

NEW

# Ice Cubic

EN:

Ice Cubic è il risultato della combinazione di due elementi: l'artigianalità Moretti Luce e la tecnologia a LED pcb.

La sfida perseguita in questi anni ha portato alla luce una plafoniera con tecnologia a LED integrata caratterizzata da un design minimal che mantiene al contempo l'effetto caratteristico dei nostri prodotti.

Ice Cubic in versione rettangolare vanta un ampio range di personalizzazione:

oltre ai molteplici colori è possibile configurare il prodotto con ben tre tipi di elettrificazione: Led 3000°K - GX53 - E27.

Presenta inoltre diversi tipi di protezione del vetro.

EN:

Ice Cubic is the result of 2 matched elements: Moretti Luce's craftsmanship and PCB LED technology.

The challenge pursued in these years has allowed to create a minimal design lamp with integrated LED technology that maintains our characteristic effect at the same time.

Ice Cubic rectangular offer a huge range of personalization: Is available in 3 finishes and Led 3000°K - GX53 or E27 electrification.

Furthermore it presents different protections for glass.

CE UK  
CA

IP65





# Ice Cubic

LED - GX53 - E27 | 360° | A Parete / Wall lamp - A Soffitto / Ceiling lamp

## SPECIFICHE TECNICHE

### Technical Specifications

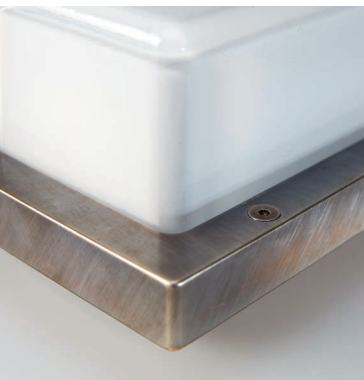

Sorgente luminosa  
Source lamp

Potenza assorbita  
Total Wattage

Voltaggio totale  
Voltage

Regolazione  
Control

Dimmer

Temperatura colore  
Light colour

Flusso nominale  
Luminous Flux

Efficienza luminosa  
Luminous efficacy

Step McADAM

Apertura cono luce  
Beam

Durata  
Life time

Classe efficienza energetica  
Energy efficiency class

Grado IP  
IP rating

Classe isolamento  
Insulation class

### LED

LED 13 W

14,5 W

220-240 V

Trasformatore incluso  
Power supply included

Dimmerabile con Dali a richiesta  
Dimmable with Dali on request

3000 K

895 lm

67 lm/W

3

Diffondente - Diffuse

L80 > 60.000 h Ta 40°C

D

IP 65

I

### GX53 - (Ø74 H23)

Micro-lynx F 1x13W

Max 13 W

220-240 V

Lampadina non inclusa  
Bulb not included

Consigliato: 3000 K  
Suggest: 3000 K

-

-

-

Diffondente - Diffuse

-

-

IP 65

I

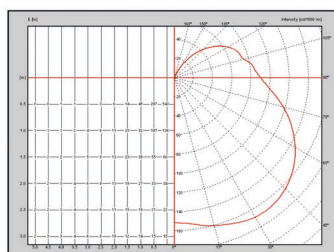
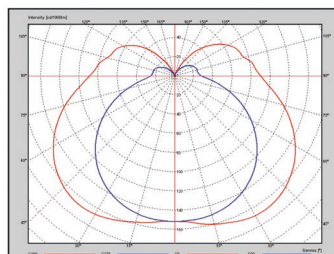

Download content:



## SPECIFICHE TECNICHE

### Technical Specifications



#### E27 (Ø65 H140)

<i>Sorgente luminosa</i> Source lamp	<u>E27 10,3W</u>
<i>Potenza assorbita</i> Total Wattage	<u>Max 20 W</u>
<i>Voltaggio totale</i> Voltage	<u>220-240 V</u>
<i>Regolazione</i> Control	<u>Lampadina non inclusa</u> <u>Bulb not included</u>
<i>Dimmer</i>	<u>-</u>
<i>Temperatura colore</i> Light colour	<u>Consigliato: 3000 K</u> <u>Suggest: 3000 K</u>
<i>Flusso nominale</i> Luminous Flux	<u>-</u>
<i>Efficienza luminosa</i> Luminous efficacy	<u>-</u>
<i>Step McADAM</i>	<u>-</u>
<i>Apertura cono luce</i> Beam	<u>Diffondente - Diffuse</u>
<i>Durata</i> Life time	<u>-</u>
<i>Classe efficienza energetica</i> Energy efficiency class	<u>-</u>
<i>Grado IP</i> IP rating	<u>IP 65</u>
<i>Classe isolamento</i> Insulation class	<u>I</u>

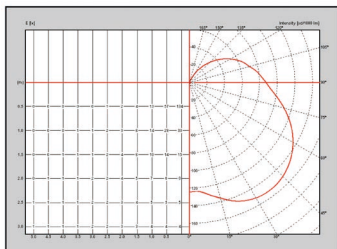
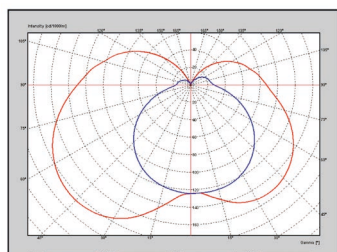





## materiali Materials

Corpo

Ottone pressofuso • Die-cast brass

Diffusore

Vetro Opale • Opal glass

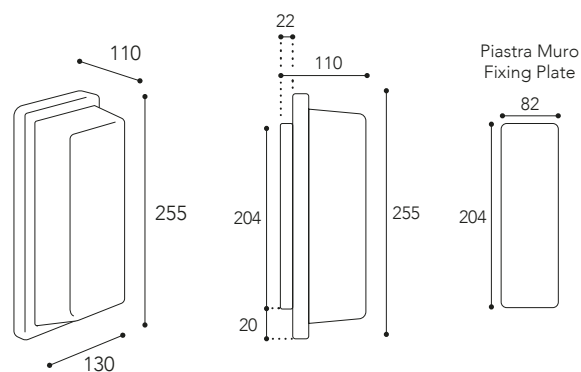

## codice ordinazione ORDER CODE

3410. . . .

Colore  
Colors

AR	Ottone anticato Aged brass	
NA	Ottone nickelato Nickeled Brass	
NB	Ottone naturale Natural brass	
1	Nero opaco Matt black	
5	Bianco opaco Matt white	
8	Grafite Matt grafite	

Elettrificazione  
Electrification

L13H	LED 3000 K
GX53	GX53*
E27	Lampadina E27 bulb*

Esempio  
Example

3410.L13H.AR

### Informazioni - Information

Lampadina non inclusa  
Bulb not included



AR non teme la salsedine  
AR no problem salt corrosion



Conforme alla direttiva UE  
Compliant with EU Directive



Conforme alla direttiva UK  
Compliant with UK Directive



(\*Lampadina non inclusa - Bulb not included)

# Ice Cubic

LED - GX53 - E27 | 360° | A Parete / Wall lamp - A Soffitto / Ceiling lamp

## SPECIFICHE TECNICHE

### Technical Specifications

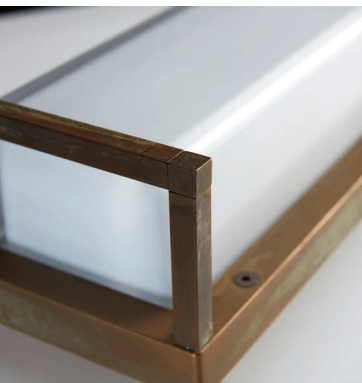

*Sorgente luminosa*  
Source lamp

*Potenza assorbita*  
Total Wattage

*Voltaggio totale*  
Voltage

*Regolazione*  
Control

*Dimmer*

*Temperatura colore*  
Light colour

*Flusso nominale*  
Luminous Flux

*Efficienza luminosa*  
Luminous efficacy

*Step McADAM*

*Apertura cono luce*  
Beam

*Durata*  
Life time

*Classe efficienza energetica*  
Energy efficiency class

*Grado IP*  
IP rating

*Classe isolamento*  
Insulation class

### LED

LED 13 W

14,5 W

220-240 V

Trasformatore incluso  
Power supply included

Dimmerabile con Dali a richiesta  
Dimmable with Dali on request

3000 K

895 lm

67 lm/W

3

Diffondente - Diffuse

L80 > 60.000 h Ta 40°C

D

IP 65

I

### GX53 - (Ø74 H23)

Micro-lynx F 1x13W

Max 13 W

220-240 V

Lampadina non inclusa  
Bulb not included

Consigliato: 3000 K  
Suggest: 3000 K

-

-

-

Diffondente - Diffuse

-

-

IP 65

I

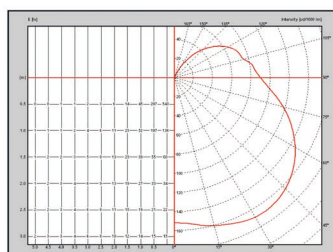
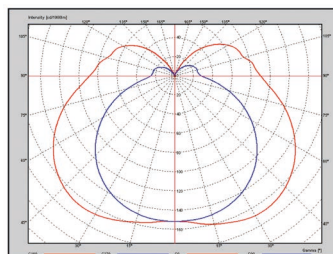

Download content:



## SPECIFICHE TECNICHE

### Technical Specifications



#### E27 (Ø65 H140)

<i>Sorgente luminosa</i> Source lamp	E27 10,3W
<i>Potenza assorbita</i> Total Wattage	Max 20 W
<i>Voltaggio totale</i> Voltage	220-240 V
<i>Regolazione</i> Control	Lampadina non inclusa Bulb not included
<i>Dimmer</i>	-
<i>Temperatura colore</i> Light colour	Consigliato: 3000 K Suggest: 3000 K
<i>Flusso nominale</i> Luminous Flux	-
<i>Efficienza luminosa</i> Luminous efficacy	-
<i>Step McADAM</i>	-
<i>Apertura cono luce</i> Beam	Diffondente - Diffuse
<i>Durata</i> Life time	-
<i>Classe efficienza energetica</i> Energy efficiency class	-
<i>Grado IP</i> IP rating	IP 65
<i>Classe isolamento</i> Insulation class	I

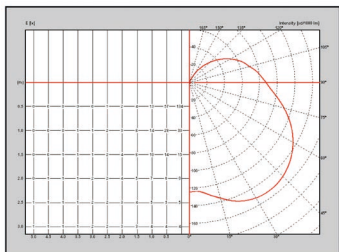
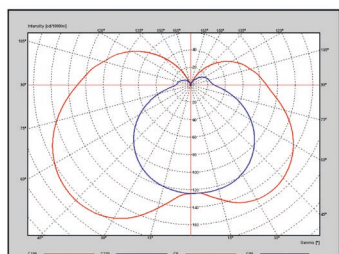



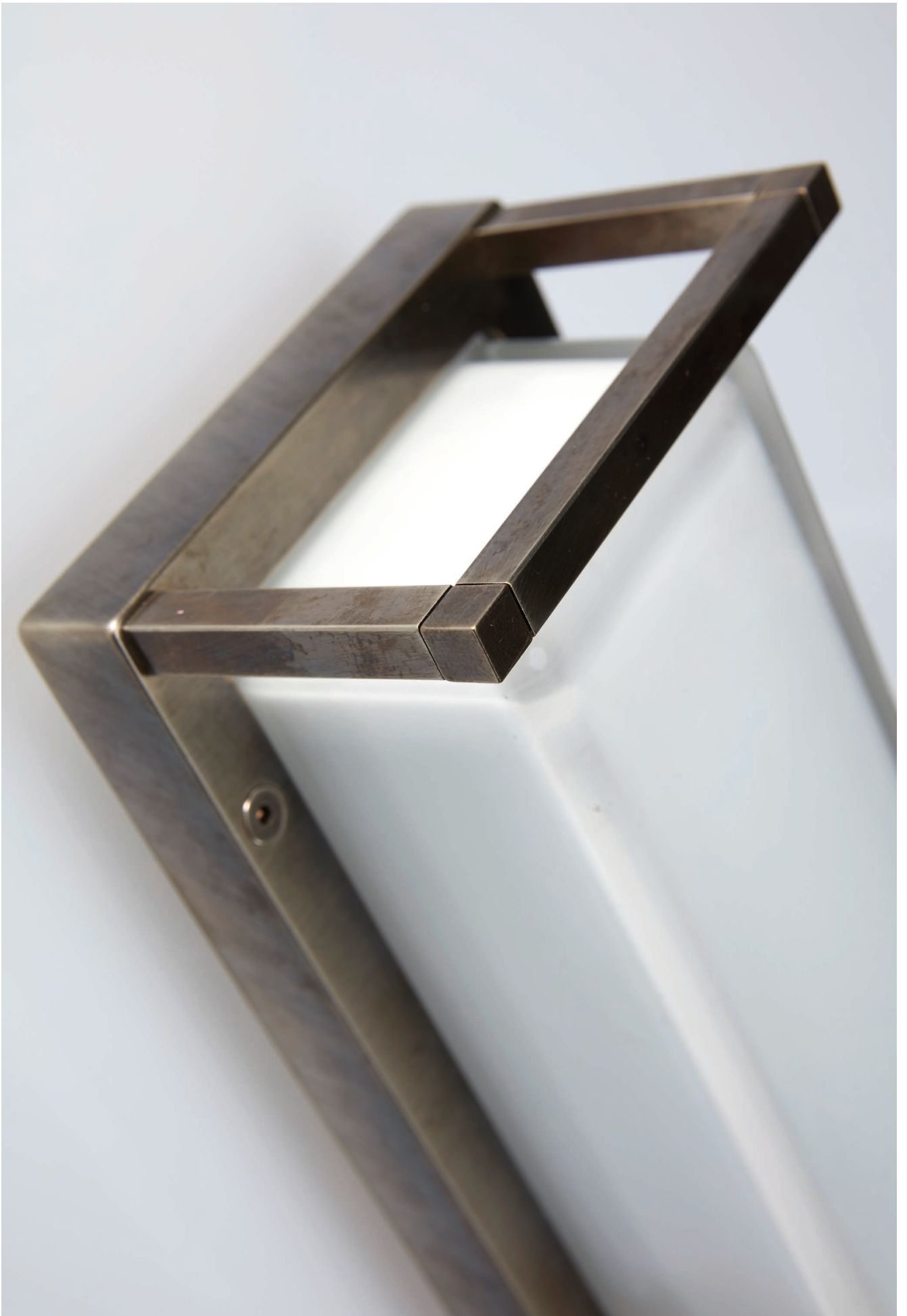

## materiali Materials

Corpo

Ottone pressofuso • Die-cast brass

Diffusore



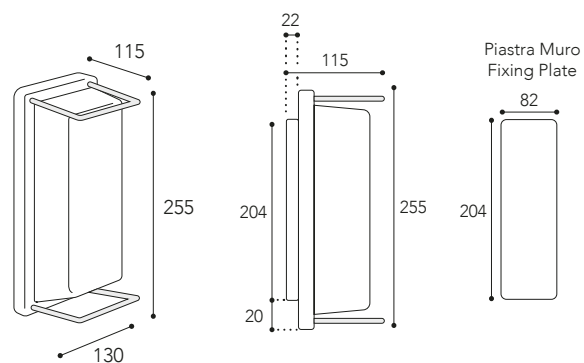



Vetro Opale • Opal glass



## codice ordinazione ORDER CODE

3412. . . .

Colore  
Colors

AR	Ottone anticato Aged brass	
NA	Ottone nickelato Nickeled Brass	
NB	Ottone naturale Natural brass	
1	Nero opaco Matt black	
5	Bianco opaco Matt white	
8	Grafite Matt grafite	

Elettrificazione  
Electrification

L13H	LED 3000 K
GX53	GX53*
E27	Lampadina E27 bulb*

Esempio  
Example

3412.L13H.AR

### Informazioni - Information

Lampadina non inclusa  
Bulb not included



AR non teme la salsedine  
AR no problem salt corrosion



Conforme alla direttiva UE  
Compliant with EU Directive



Conforme alla direttiva UK  
Compliant with UK Directive



(\*Lampadina non inclusa - Bulb not included)

# Ice Cubic

LED - GX53 - E27 | 360° | A Parete / Wall lamp - A Soffitto / Ceiling lamp

## SPECIFICHE TECNICHE

### Technical Specifications

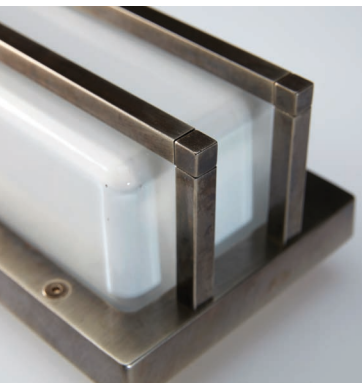

Sorgente luminosa  
Source lamp

Potenza assorbita  
Total Wattage

Voltaggio totale  
Voltage

Regolazione  
Control

Dimmer

Temperatura colore  
Light colour

Flusso nominale  
Luminous Flux

Efficienza luminosa  
Luminous efficacy

Step McADAM

Apertura cono luce  
Beam

Durata  
Life time

Classe efficienza energetica  
Energy efficiency class

Grado IP  
IP rating

Classe isolamento  
Insulation class

### LED

LED 13 W

14,5 W

220-240 V

Trasformatore incluso  
Power supply included

Dimmerabile con Dali a richiesta  
Dimmable with Dali on request

3000 K

895 lm

67 lm/W

3

Diffondente - Diffuse

L80 > 60.000 h Ta 40°C

D

IP 65

I

### GX53 - (Ø74 H23)

Micro-lynx F 1x13W

Max 13 W

220-240 V

Lampadina non inclusa  
Bulb not included

-

Consigliato: 3000 K  
Suggest: 3000 K

-

-

-

Diffondente - Diffuse

-

-

IP 65

I

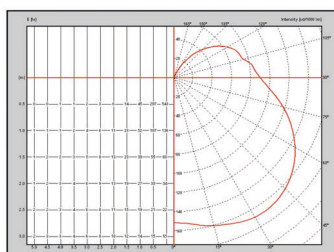
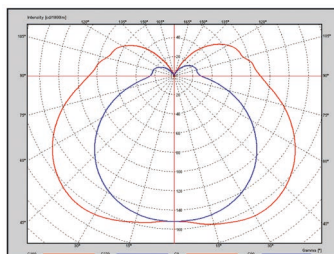

Download content:



## SPECIFICHE TECNICHE

### Technical Specifications



#### E27 (Ø65 H140)

Sorgente luminosa Source lamp	E27 10,3W
Potenza assorbita Total Wattage	Max 20 W
Voltaggio totale Voltage	220-240 V
Regolazione Control	Lampadina non inclusa Bulb not included
Dimmer	-
Temperatura colore Light colour	Consigliato: 3000 K Suggest: 3000 K
Flusso nominale Luminous Flux	-
Efficienza luminosa Luminous efficacy	-
Step McADAM	-
Apertura cono luce Beam	Diffondente - Diffuse
Durata Life time	-
Classe efficienza energetica Energy efficiency class	-
Grado IP IP rating	IP 65
Classe isolamento Insulation class	I

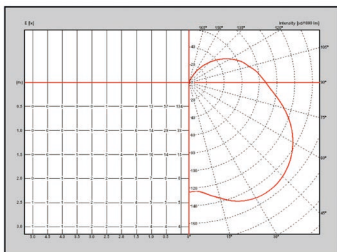
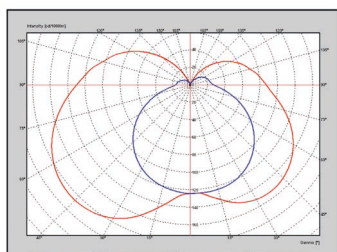





## materiali Materials

Corpo

Ottone pressofuso • Die-cast brass

Diffusore

Vetro Opale • Opal glass

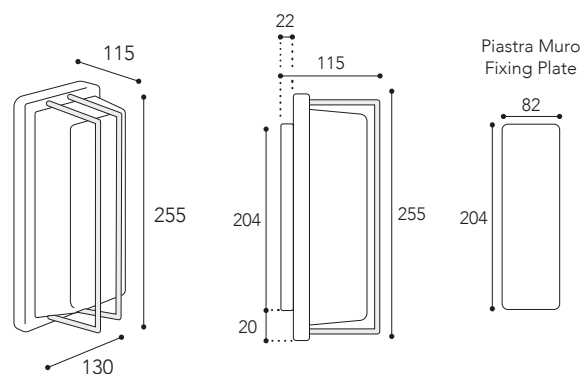

## codice ordinazione ORDER CODE

3413. . . .

Colore  
Colors

AR	Ottone anticato Aged brass	
NA	Ottone nickelato Nickelated Brass	
NB	Ottone naturale Natural brass	
1	Nero opaco Matt black	
5	Bianco opaco Matt white	
8	Grafite Matt grafite	

Elettrificazione  
Electrification

L13H	LED 3000 K
GX53	GX53*
E27	Lampadina E27 bulb*

Esempio  
Example

3413.L13H.AR

### Informazioni - Information

Lampadina non inclusa  
Bulb not included



AR non teme la salsedine  
AR no problem salt corrosion



Conforme alla direttiva UE  
Compliant with EU Directive



Conforme alla direttiva UK  
Compliant with UK Directive



(\*Lampadina non inclusa - Bulb not included)

NEW

# Ice Cubic

LED - GX53 - E27 | 360° | A Parete / Wall lamp - A Soffitto / Ceiling lamp

## SPECIFICHE TECNICHE

### Technical Specifications



Sorgente luminosa  
Source lamp

Potenza assorbita  
Total Wattage

Voltaggio totale  
Voltage

Regolazione  
Control

Dimmer

Temperatura colore  
Light colour

Flusso nominale  
Luminous Flux

Efficienza luminosa  
Luminous efficacy

Step McADAM

Apertura cono luce  
Beam

Durata  
Life time

Classe efficienza energetica  
Energy efficiency class

Grado IP  
IP rating

Classe isolamento  
Insulation class

### LED

LED 13 W

14,5 W

220-240 V

Trasformatore incluso  
Power supply included

Dimmerabile con Dali a richiesta  
Dimmable with Dali on request

3000 K

895 lm

67 lm/W

3

Diffondente - Diffuse

L80 > 60.000 h Ta 40°C

D

IP 65

I

### GX53 - (Ø74 H23)

Micro-lynx F 1x13W

Max 13 W

220-240 V

Lampadina non inclusa  
Bulb not included

Consigliato: 3000 K  
Suggest: 3000 K

-

-

-

Diffondente - Diffuse

-

-

IP 65

I

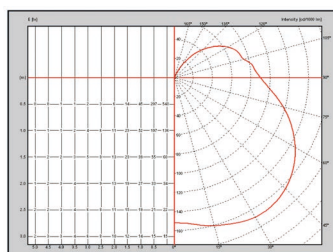
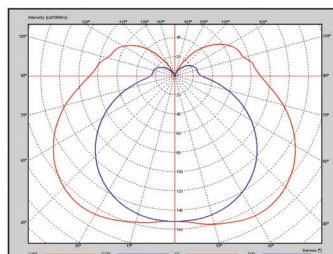

Download content:



## SPECIFICHE TECNICHE

### Technical Specifications



Sorgente luminosa  
Source lamp

**E27 (Ø65 H140)**

E27 10,3W

Potenza assorbita  
Total Wattage

Max 20 W

Voltaggio totale  
Voltage

220-240 V

Regolazione  
Control

Lampadina non inclusa  
Bulb not included

Dimmer

-

Temperatura colore  
Light colour

Consigliato: 3000 K  
Suggest: 3000 K

Flusso nominale  
Luminous Flux

-

Efficienza luminosa  
Luminous efficacy

-

Step McADAM

-

Apertura cono luce  
Beam

Diffondente - Diffuse

Durata  
Life time

-

Classe efficienza energetica  
Energy efficiency class

-

Grado IP  
IP rating

IP 65

Classe isolamento  
Insulation class

I

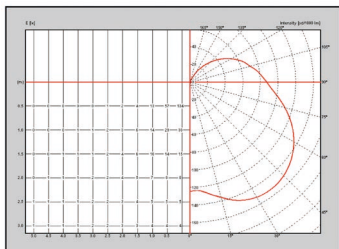
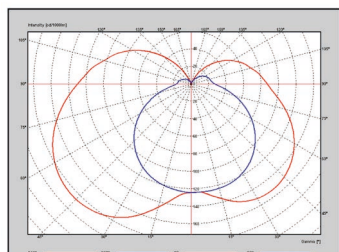

EUIPO  
Certificate of registration

015021990-0014



NEW



## materiali Materials

Corpo

Ottone pressofuso • Die-cast brass

Diffusore

Vetro Opale • Opal glass

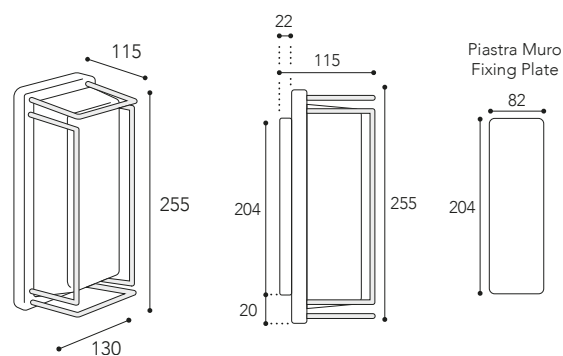

## codice ordinazione ORDER CODE

3414.

Colore  
Colors

AR	Ottone anticato Aged brass	
NA	Ottone nickelato Nickeled Brass	
NB	Ottone naturale Natural brass	
1	Nero opaco Matt black	
5	Bianco opaco Matt white	
8	Grafite Matt grafite	

Elettrificazione  
Electrification

L13H	LED 3000 K
GX53	GX53*
E27	Lampadina E27 bulb*

Esempio  
Example

3414.L13H.AR

### Informazioni - Information

Lampadina non inclusa  
Bulb not included



AR non teme la salsedine  
AR no problem salt corrosion



Conforme alla direttiva UE  
Compliant with EU Directive



Conforme alla direttiva UK  
Compliant with UK Directive



(\*Lampadina non inclusa - Bulb not included)



# Ice Cubic

LED - GX53 - E27 | 360° | A Parete / Wall lamp - A Soffitto / Ceiling lamp

## SPECIFICHE TECNICHE

### Technical Specifications



Sorgente luminosa  
Source lamp

Potenza assorbita  
Total Wattage

Voltaggio totale  
Voltage

Regolazione  
Control

Dimmer

Temperatura colore  
Light colour

Flusso nominale  
Luminous Flux

Efficienza luminosa  
Luminous efficacy

Step McADAM

Apertura cono luce  
Beam

Durata  
Life time

Classe efficienza energetica  
Energy efficiency class

Grado IP  
IP rating

Classe isolamento  
Insulation class

### LED

LED 13 W

14,5 W

220-240 V

Trasformatore incluso  
Power supply included

Dimmerabile con Dali a richiesta  
Dimmable with Dali on request

3000 K

895 lm

67 lm/W

3

Diffondente - Diffuse

L80 > 60.000 h Ta 40°C

D

IP 65

I

### GX53 - (Ø74 H23)

Micro-lynx F 1x13W

Max 13 W

220-240 V

Lampadina non inclusa  
Bulb not included

Consigliato: 3000 K  
Suggest: 3000 K

-

-

-

Diffondente - Diffuse

-

-

IP 65

I

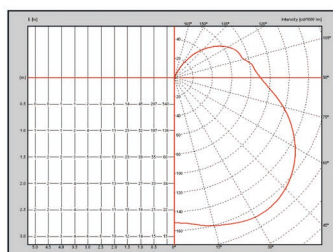
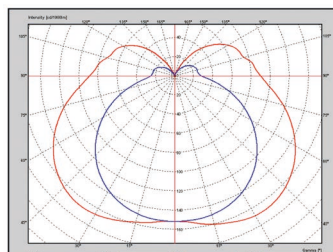

Download content:



## SPECIFICHE TECNICHE

### Technical Specifications



#### E27 (Ø65 H140)

Sorgente luminosa Source lamp	E27 10,3W
Potenza assorbita Total Wattage	Max 20 W
Voltaggio totale Voltage	220-240 V
Regolazione Control	Lampadina non inclusa Bulb not included
Dimmer	-
Temperatura colore Light colour	Consigliato: 3000 K Suggest: 3000 K
Flusso nominale Luminous Flux	-
Efficienza luminosa Luminous efficacy	-
Step McADAM	-
Apertura cono luce Beam	Diffondente - Diffuse
Durata Life time	-
Classe efficienza energetica Energy efficiency class	-
Grado IP IP rating	IP 65
Classe isolamento Insulation class	I

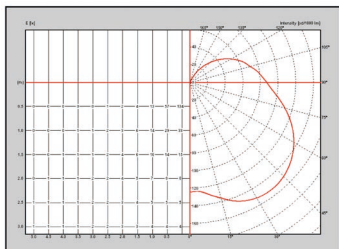
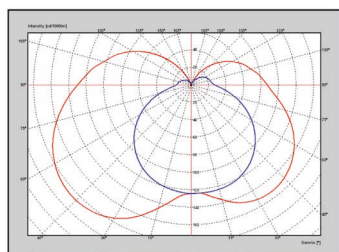



## materiali Materials

Corpo

Ottone pressofuso • Die-cast brass

Diffusore

Vetro Opale • Opal glass

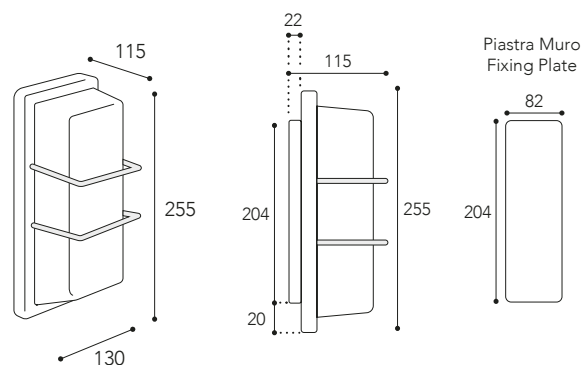

## codice ordinazione ORDER CODE

3415. \_ \_ \_

Colore  
Colors

AR	Ottone anticato Aged brass	
NA	Ottone nickelato Nickeled Brass	
NB	Ottone naturale Natural brass	
1	Nero opaco Matt black	
5	Bianco opaco Matt white	
8	Grafite Matt grafite	

Elettrificazione  
Electrification

L13H	LED 3000 K
GX53	GX53*
E27	Lampadina E27 bulb*

Esempio  
Example

3415.L13H.AR

### Informazioni - Information

Lampadina non inclusa  
Bulb not included



AR non teme la salsedine  
AR no problem salt corrosion



Conforme alla direttiva UE  
Compliant with EU Directive



Conforme alla direttiva UK  
Compliant with UK Directive



(\*Lampadina non inclusa - Bulb not included)

# Ice Cubic

Altre prospettive | Other perspectives

	Aged brass (.AR)	Nickel brass (.NA)	Natural brass (.NB)	Matt black Ral 9005 (.1)
3410				
3412				
3413				
<b>NEW</b> 3414				
3415				



# Ice Cubic

Altre prospettive | Other perspectives

Matt white  
Ral 9016  
(.5)

Matt graphite  
Ral 7024  
(.8)

Frontale/front

Laterale/lateral

Orizzontale  
Horizontal

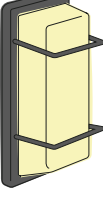
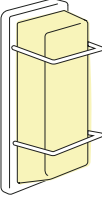
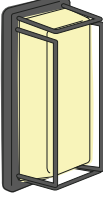
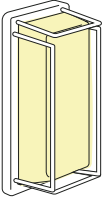
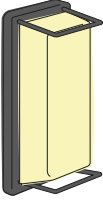
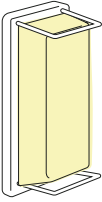
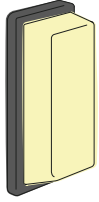
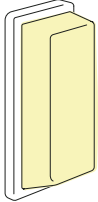

# IT Collegamento a vista in serie





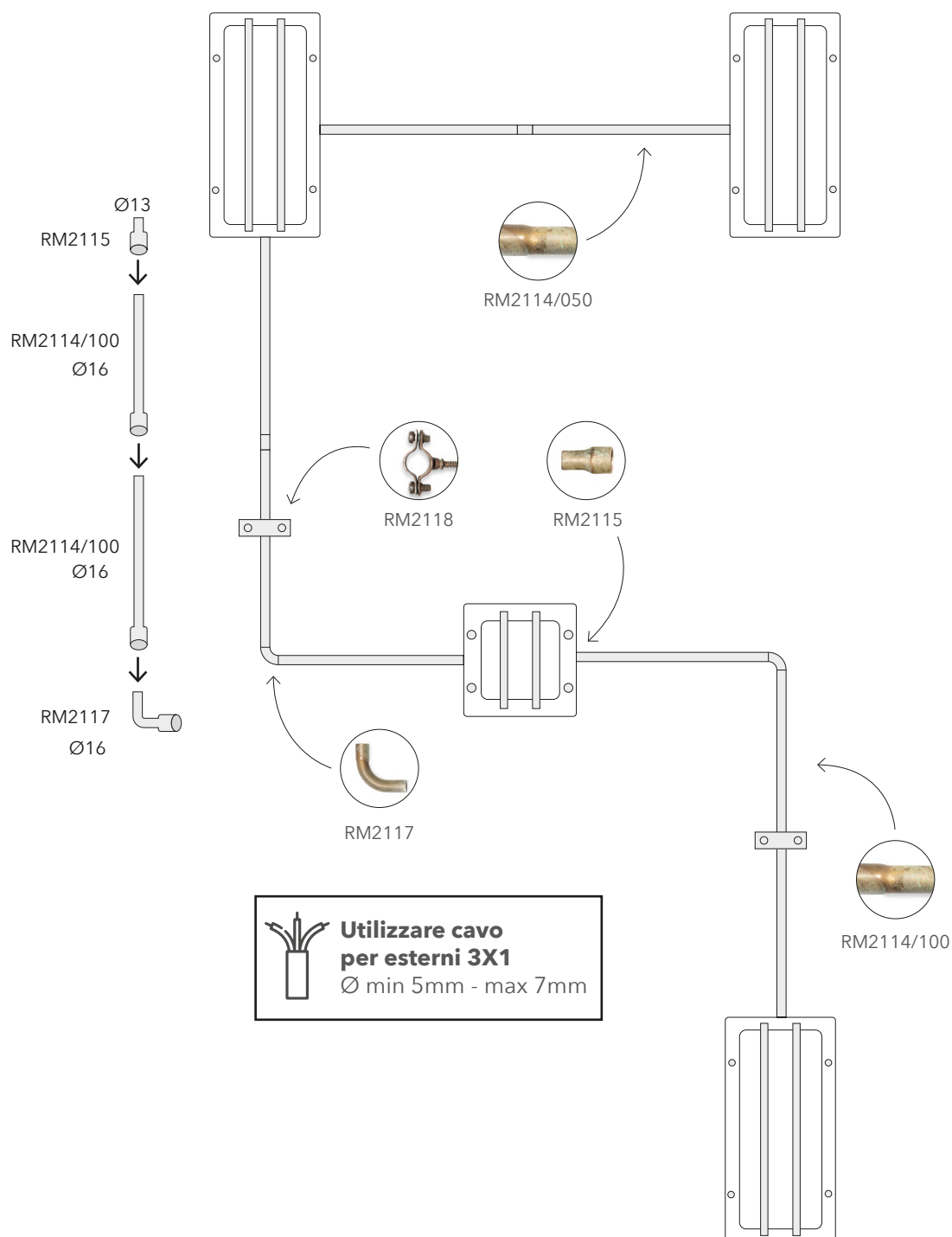

In tutti i modelli delle linee Ice Cubic square e rectangular è possibile realizzare un collegamento in serie che permette di alimentare molteplici lampade con una sola fonte di alimentazione.

Questa soluzione permette di creare un collegamento elettrico efficiente ed elegante dove non ne esiste uno a muro.

Inoltre, il nostro sistema, è stato studiato per mantenere sulla nostra lampada il grado di protezione IP 65.



## Componenti:

Codice	Descrizione	
RM2114/50	Tubo in ottone 50 cm	
RM2114/100	Tubo in ottone 100 cm	
RM2115	Manicotto in ottone da lampada a tubo	 Ø13
RM2116	Raccordo semplice in ottone	
RM2117	Raccordo a curva in ottone	
RM2118	Collare fermatubi in ottone con vite e tassello	

**Diametro di tutte le componenti Ø16mm**

## Come forare la piastra:

Per il modello rettangolare è possibile forare la piastra su tutti e 4 i lati, mentre nella versione quadrata solo su i due laterali.

Potete forare le piastre con le seguenti indicazioni:

Effettuare con un trapano, nelle apposite vaschette situate nel retro della piastra, i fori del diametro di **Ø13,1 mm** per inserire l'articolo **RM 2115** del diametro **Ø13 mm**.

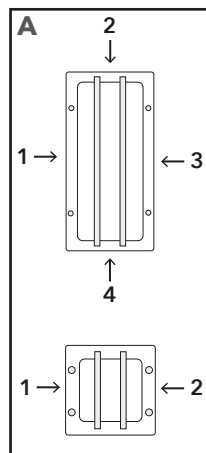

## Come ordinare la piastra forata:

In alternativa possiamo forare per voi le piastre.

È fondamentale indicarci i numeri di fori come riportato nella **figura A**, ed effettuare l'ordine come d'esempio qui in basso:

## Esempio:

3413.L13H.AR + Foro 1 e 4

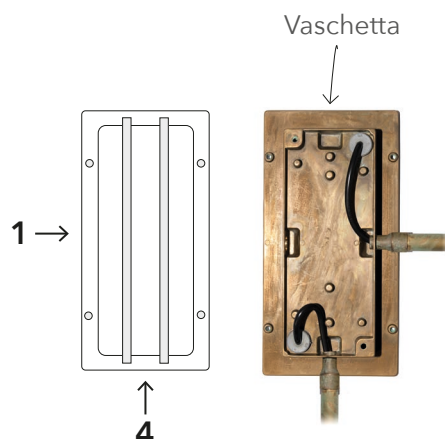

# EN Visible connection in series





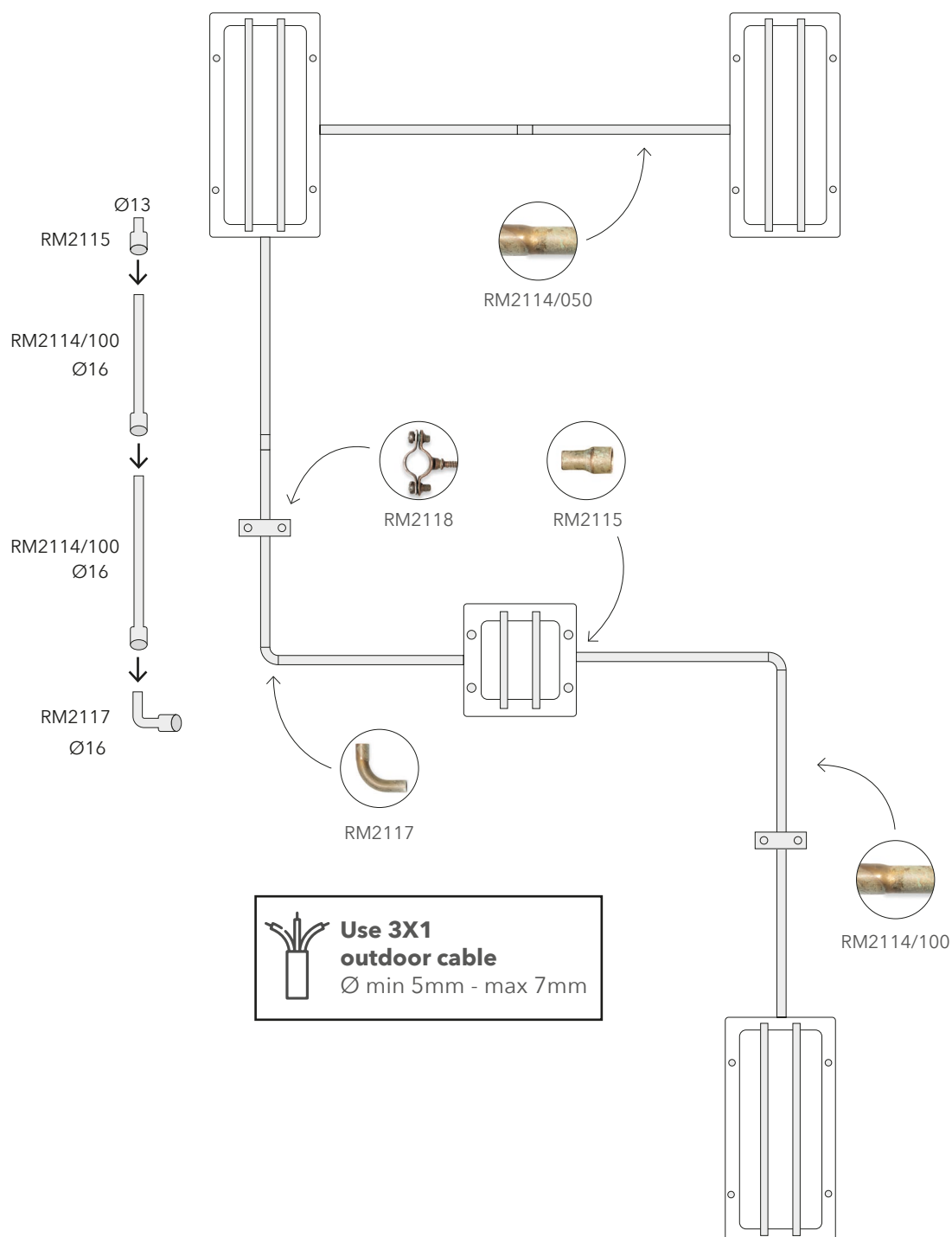

In all models of the Ice Cubic square and rectangular lines, it is possible to make a series connection that allows multiple lamps to be powered by a single power source.

This solution makes it possible to create an efficient and elegant electrical connection where one does not exist on the wall.

In addition, our system has been designed to maintain IP65 protection on our lamp.



## Components:

Code	Description	
RM2114/50	Brass tube 50 cm	
RM2114/100	Brass tube 100 cm	
RM2115	Brass sleeve from lamp to tube	 Ø13
RM2116	Brass simple fitting	
RM2117	Brass bend fitting	
RM2118	Brass pipe stop collar with screw and plug	

**Diameter of all components Ø16mm**

### How to drill the plate:

For the rectangular model you can drill the plate on all 4 sides, while in the square version only on two sides.

You can drill the plates in the following directions:

With a drill make in the appropriate trays located in the back of the plate, holes of **Ø13,1 mm** to insert the **RM 2115** of **Ø13 mm**.

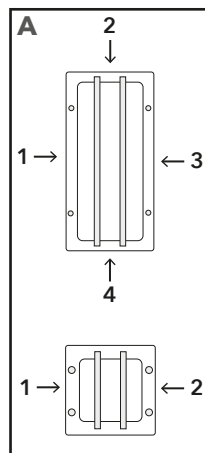

### How to order the perforated plate:

Alternatively, we can drill the plates for you. It is essential to tell us the number of holes as shown in **figure A**, and place the order as per the example below:

### Example:

3413.L13H.AR + Hole 1 e 4

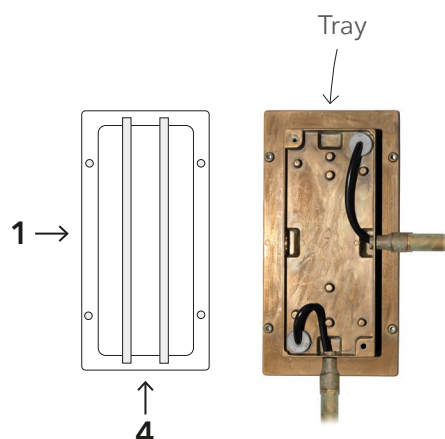



## FR Connexion visible en série





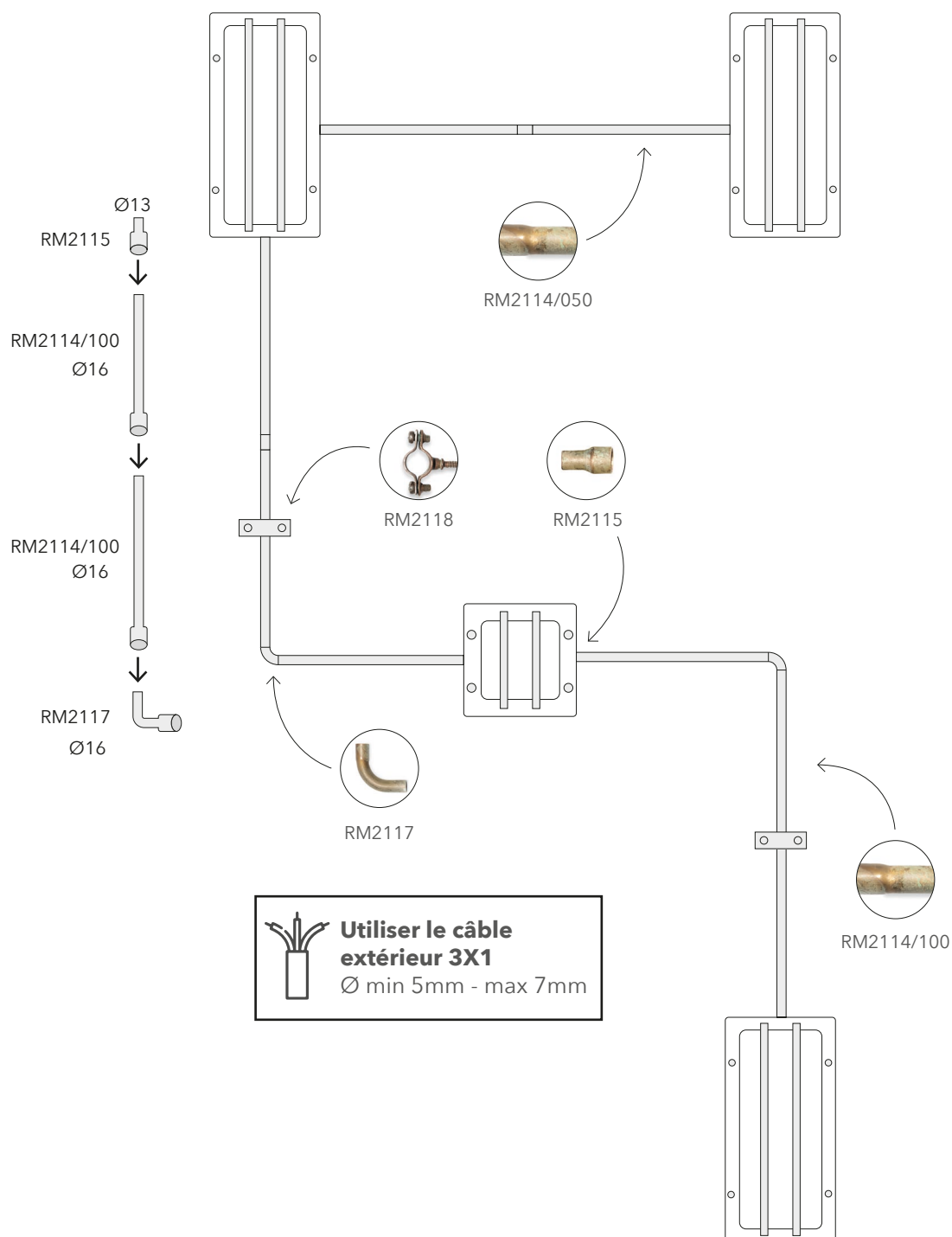

Choisissez la configuration que vous souhaitez grâce à nos tubes laiton et nos accessoires adaptés (angles, fixations, manchons etc...) sur tous les modèles ICE CUBIC. A partir d'un seul point lumineux, il est possible de réaliser votre propre configuration avec plusieurs modèles (luminaire équipé d'un repiquage).

Cette solution peut faciliter vos installations électriques et vous offrir une installation efficace et élégante.

En outre, notre système est conçu pour conserver la protection IP65 sur nos lampes



## Composants:

Le code	Description	
RM2114/50	Tube en laiton 50 cm	
RM2114/100	Tube en laiton 100 cm	
RM2115	Raccord jonction luminaire	 Ø13
RM2116	Raccord simple en laiton	
RM2117	Raccord coudé en laiton	
RM2118	Collier de serrage en laiton avec vis et bouchon	

**Diamètre de tous les composants Ø16mm**

### Comment percer le socle du luminaire:

Pour le modèle rectangulaire il est possible de percer le support sur les quatre côtés, contrairement à la version carrée, ce sera seulement deux côtés.

Comment percer le socle :

A l'aide d'une perceuse et d'un foret de diamètre **Ø13,1 mm** percer le socle pour insérer l'article **RM 2115**.

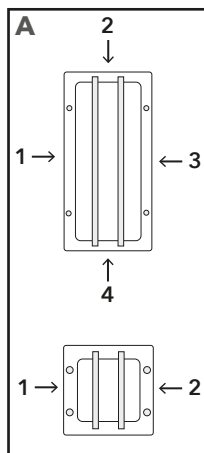

### Comment commander le socle déjà percé :

Nous pouvons percer les socles dans nos ateliers. Il est essentiel que vous nous indiquiez les numéros de trous tels qu'ils figurent dans le document de référence **figure A**, et passer la commande comme dans l'exemple ci-dessous:

### Exemple:

3413.L13H.AR + Trou 1 e 4

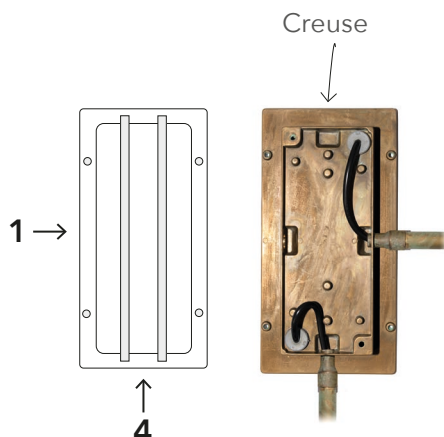

# DE Sichtbare Verbindung in Reihe





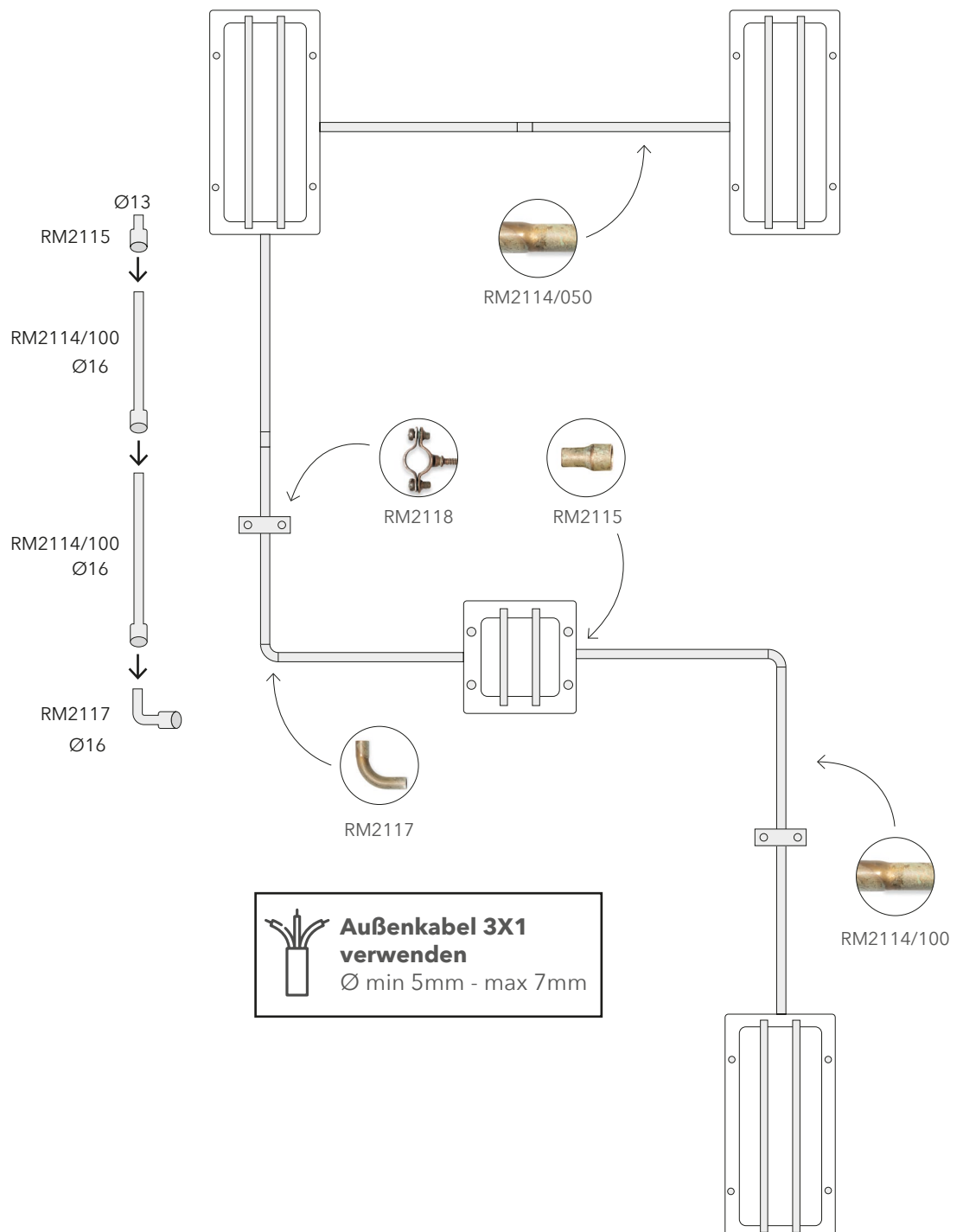

Bei allen Modellen der quadratischen und rechteckigen Ice Cubic-Linien ist es möglich, eine Reihenschaltung zu realisieren, die es erlaubt, mehrere Lampen mit einer einzigen Stromquelle zu betreiben.

Diese Lösung ermöglicht es, einen effizienten und eleganten elektrischen Anschluss zu schaffen, wo es keinen an der Wand gibt.

Darüber hinaus ist unser System so konzipiert, dass unsere Lampe die Schutzart IP 65 aufweist.



## Komponenten:

Code	Beschreibung	
RM2114/50	Messingrohr 50 cm	
RM2114/100	Messingrohr 100 cm	
RM2115	Messingmuffe von Lampe zu Rohr	 Ø13
RM2116	Einfacher Messingfitting	
RM2117	Messing-Krümmen-Kupplung	
RM2118	Rohrschellenkragen aus Messing mit Schraube und Stecker	

### Durchmesser aller Komponenten Ø16mm

### So bohren Sie die Platte:

Bei der rechteckigen Ausführung kann die Platte an allen vier Seiten gebohrt werden, bei der quadratischen Ausführung nur an zwei Seiten.

So bohren sie die Platte:

Bohren Sie mit einem Bohrer in die Schalen auf der Rückseite der Platte, Löcher mit einem Durchmesser von **Ø13,1 mm**. So fügen Sie den Artikel **RM 2115** mit einem Durchmesser **Ø13 mm** ein.

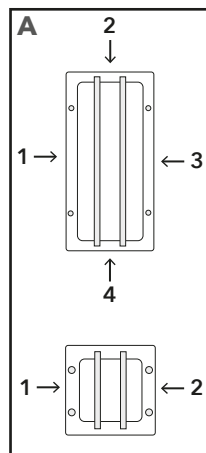

### So bestellen sie das Lochblech:

Alternativ können wir die Platten auch für Sie bohren. Es ist wichtig, dass Sie uns die Lochnummeee mitteilen, **wie in Abbildung A**, und geben Sie die Bestellung wie im folgenden Beispiel auf:

### Beispiel:

3413.L13H.AR + Loch 1 e 4

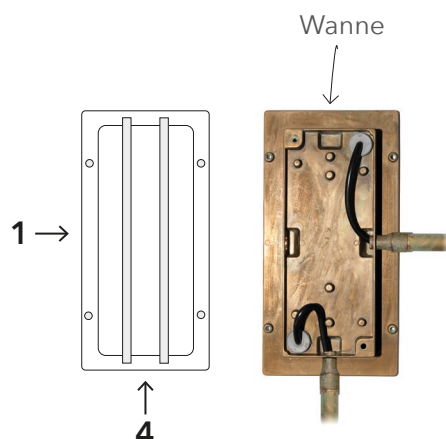

## ES Conexión visible en serie

En todos los modelos Ice Cubic, tanto de la línea cuadrada como de la rectangular, es posible realizar una conexión en serie que permite alimentar varias lámparas con una única fuente de alimentación.





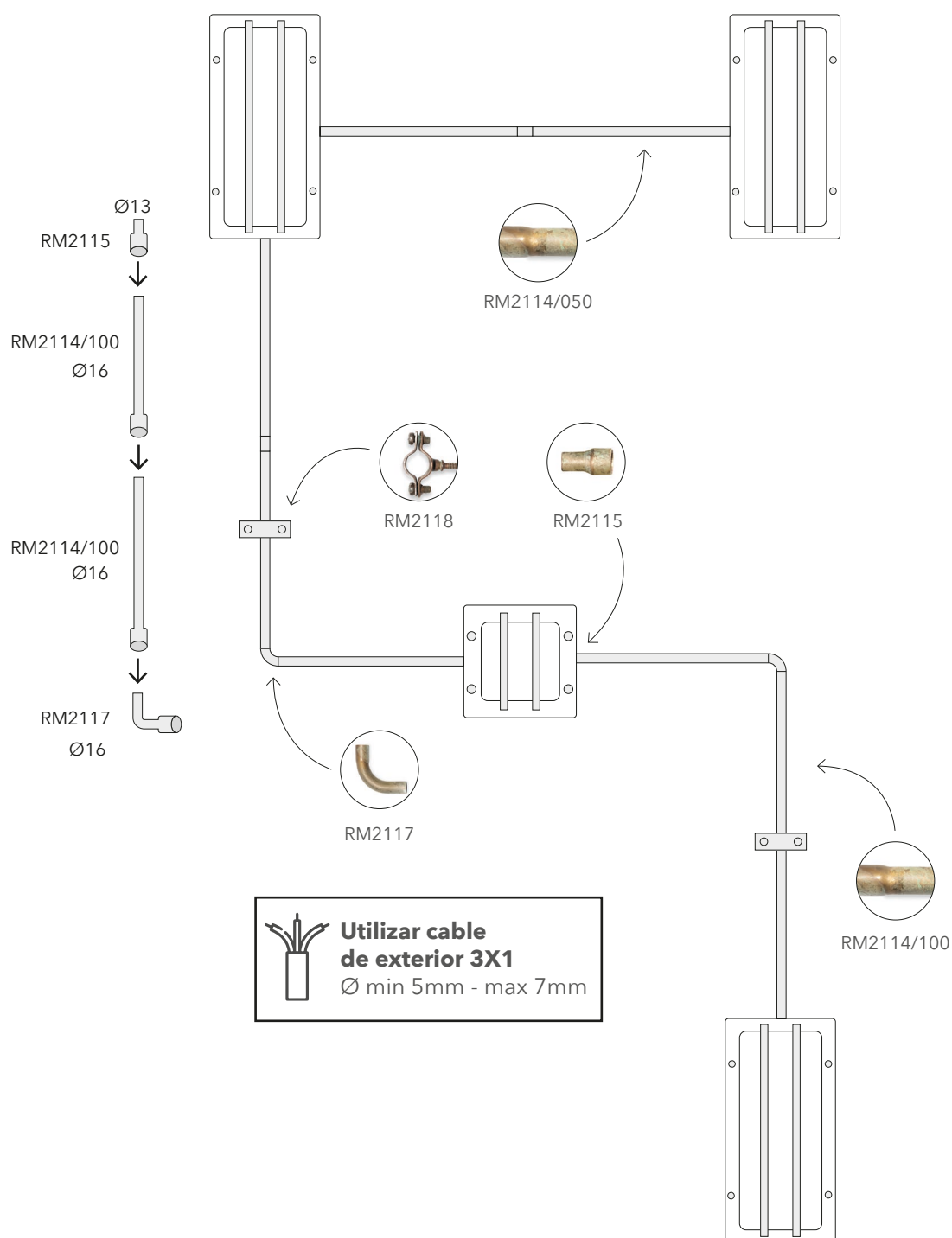

Esta solución permite crear una conexión eficaz aportando una estética elegante a la instalación.

Además, nuestro sistema está diseñado para mantener un grado de protección IP 65 en la lámpara.





## Componentes:

Código	Descripción	
RM2114/50	Tubo de latón 50 cm	
RM2114/100	Tubo de latón 100 cm	
RM2115	Manguito de latón de la lámpara al tubo	 Ø13
RM2116	Racor simple de latón	
RM2117	Codo de latón	
RM2118	Collarín de sujeción de tubo de latón con tornillo y tapón	

**Diámetro de todos los componentes Ø16mm**

### Cómo perforar la placa:

En la línea Ice Cubic rectangular, es posible taladrar la placa en los cuatro lados, mientras que, en la cuadrada, solo en dos de ellos.

Utilice un taladro para perforar las bandejas situadas en la parte posterior de la placa. Los agujeros deben tener un diámetro de **Ø13,1 mm** para poder insertar la referencia **RM 2115** cuyo diámetro es de **Ø13 mm**.

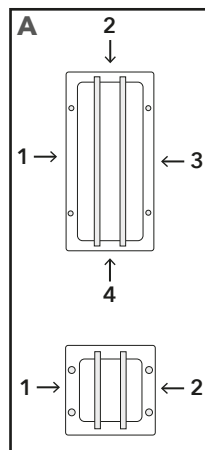

### Cómo pedir la placa ya perforada:

Como alternativa, se pueden pedir las placas ya perforadas en nuestras instalaciones. Para ello, es imprescindible que nos indique la cantidad de agujeros (tal y como se muestra en la **figura A**) y que realice su pedido como se indica en el siguiente ejemplo:

### Ejemplo:

3413.L13H.AR + Agujero 1 y 4

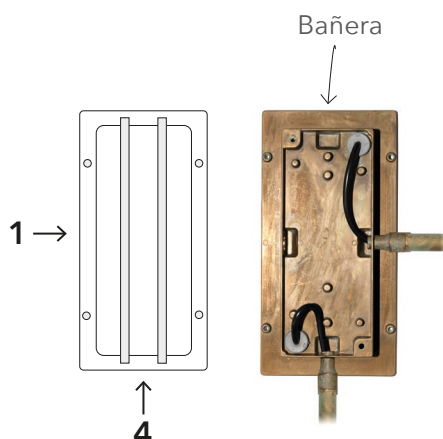

NEW





NEW

