

EGOLUCE s.r.l. - via I. Newton, 12 - 20016 Pero, Milano - Italy
Tel. +39 02339586.1 - Fax +39 023535112 - www.egoluce.com info@egoluce.com

Solo l'uso corretto delle istruzioni garantisce la sicurezza dell'apparecchio:
E' NECESSARIO CONSERVARLE
Disinserire la tensione prima di ogni intervento sull'apparecchio. Per un corretto montaggio vedere lo schema allegato. Non dimmerabile.

This equipment is guaranteed only if used as indicated in these instructions:
PRESERVE THIS INSTRUCTIONS
Before any operation on this equipment, disconnect the power supply.
For a correct assembling see the here enclosed diagram. Not dimmable.

La sécurité de l'appareil n'est garantie que par le respect des instructions suivantes.
IL EST NECESSAIRE LES CONSERVER
Disjoindre le courant de reseau avant tout operation sur l'appareil. Pour le montage suivre le schéma ici-joint. Pas dimmable..

Nur bei Befolgung der nachfolgenden Anweisungen, ist die Sicherheit des Gerats gewährleistet.
AUFBEWAHREN SIE BITTE DIE ANWEISUNGEN
Abschalten die Netzspannung vor Ausweshsen der lampe. Fur eine einwaldfrei Montage siehe Beigefutges. Nicht dimmabar.

Solamente el correcto cumplimiento de las instrucciones puede garantizar la seguridad del aparato:
ES NECESARIO CUMPLIRLAS.
Desconectar la tensión antes de cualquiera intervención en el aparato. Para un ensamblaje correcto, consultar el esquema adjunto. No regulables.

 Questo prodotto non deve essere smaltito come rifiuto municipale misto, effettuare una raccolta separata.
This product must not be discarded as the responsibility of the City sanitation department, it must be gathered together separately and discarded.
Ce produit ne doit pas être mis avec les ordures municipales, il faut effectuer un ramassage séparé.
Dieses Produkt darf nicht als Gemeindekehricht entsorgt werden. Entsorgung muss getrennt erfolgen.
Este producto no puede ser desechado como basura municipal mixta, efectuar recogida selectiva.

 Apparecchio adatto ad essere installato su superfici normalmente infiammabili.
Appareil pouvant être installé sur des surfaces normalement inflammables.
Fixture ready for mouting on normally inflammable surfaces.
Apparat, der auf normal entflammbare Oberflächen angebracht werden kann.
Aparato idóneo para ser utilizado en superficies normalmente inflamables.

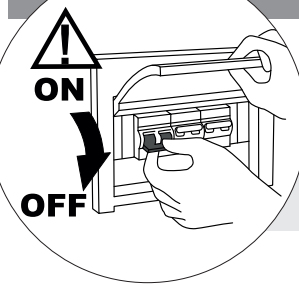

Per evitare di danneggiare il LED effettuare tutti i collegamenti prima di dare tensione
To avoid damages to LED unit all connection shall be made before to switch power on

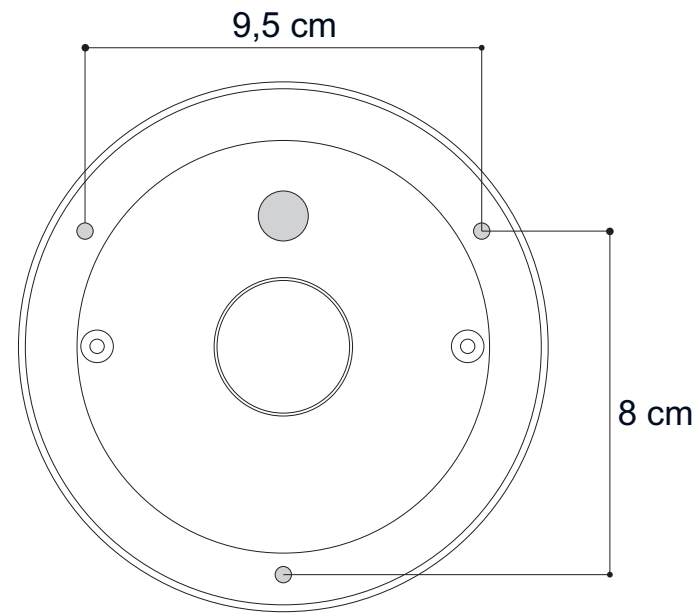

Interasse fori fissaggio *Distance between fixing holes*

A

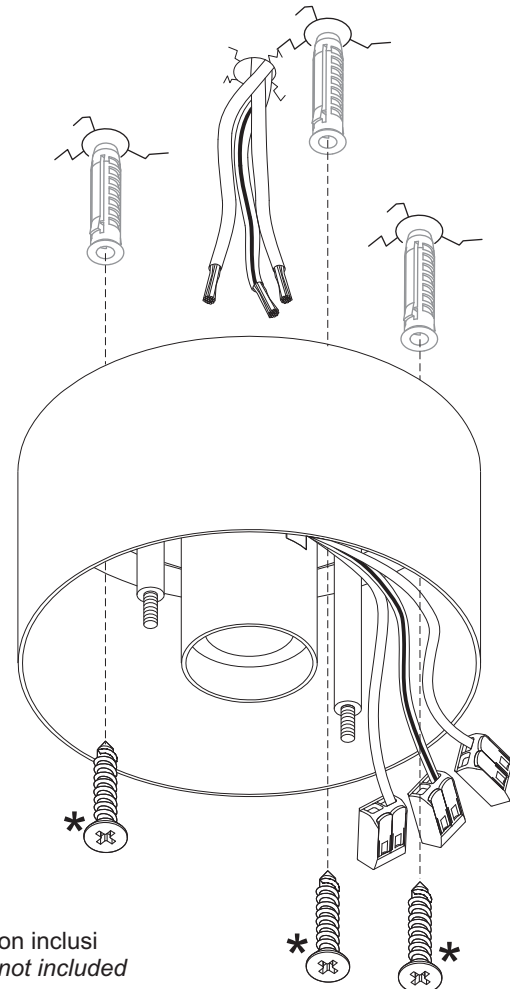

* Viti e tasselli non inclusi
Screw and plugs not included

B

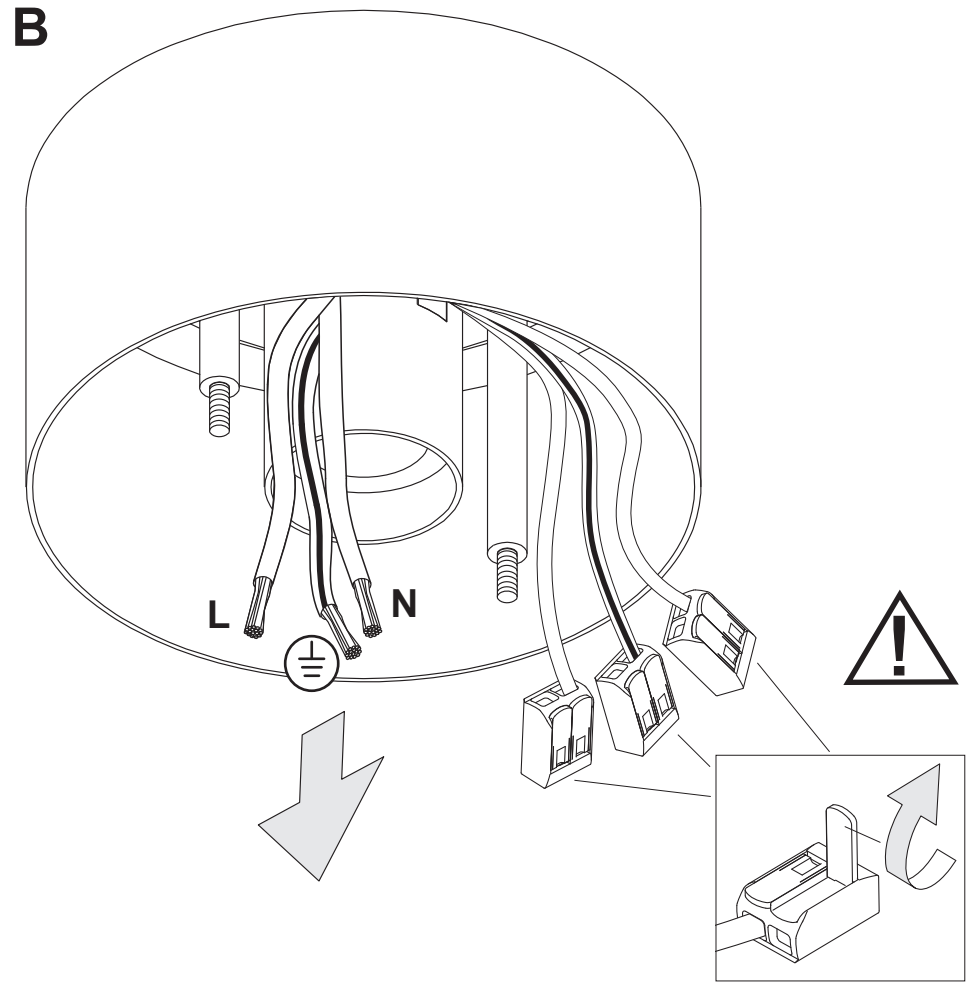

C

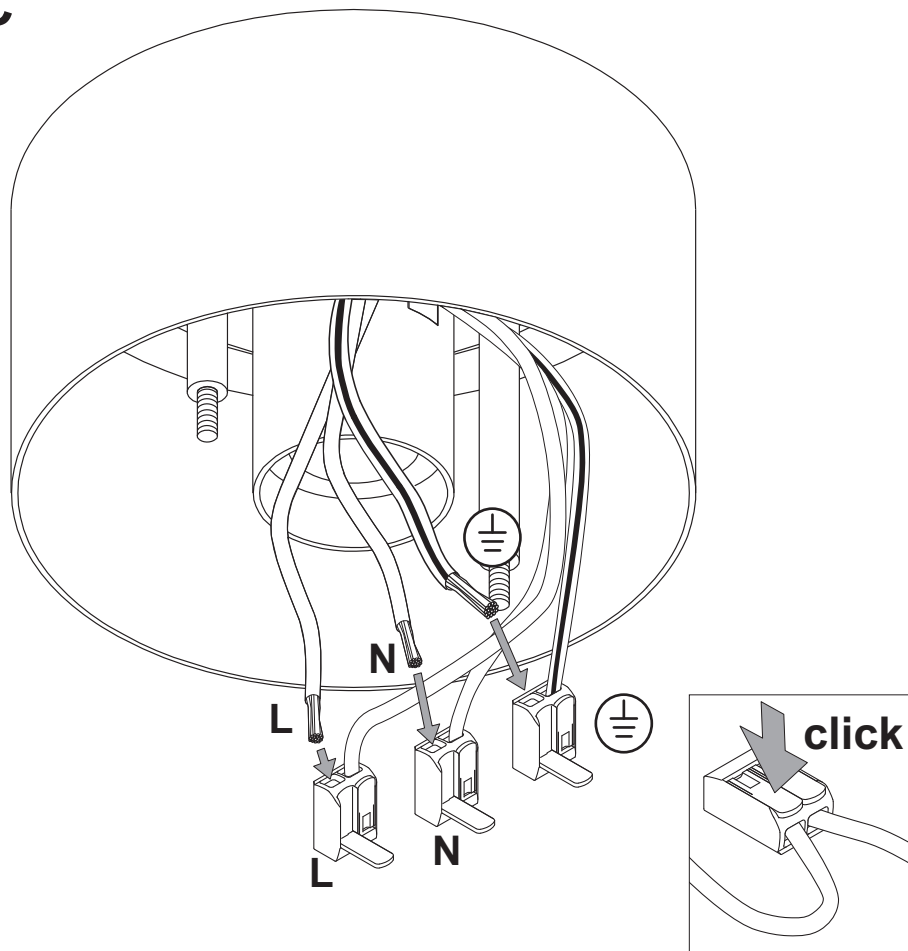

D

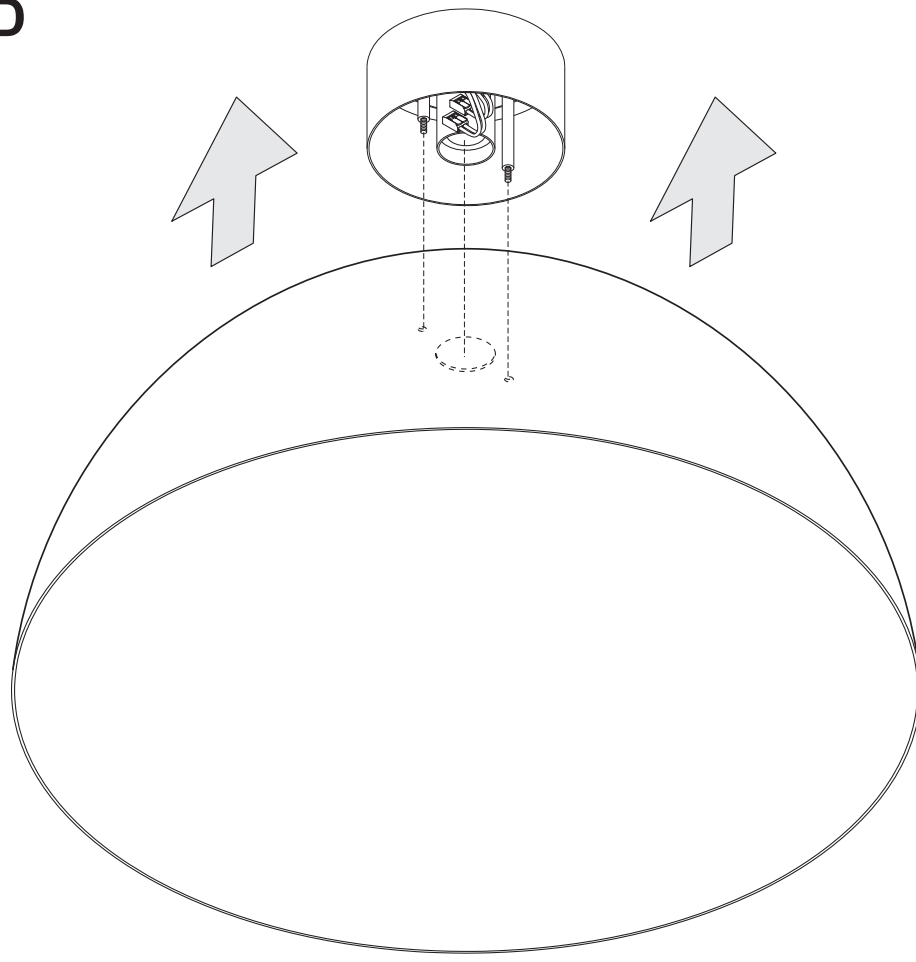

E

