

DEEP BIJOU

INSTALLATION INSTRUCTIONS | FEBRUARY 2023

1.0 LED

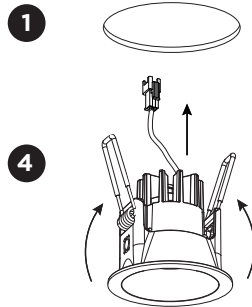

2.0 LED

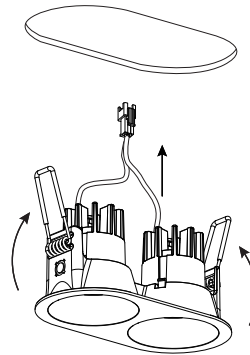

hole dimension

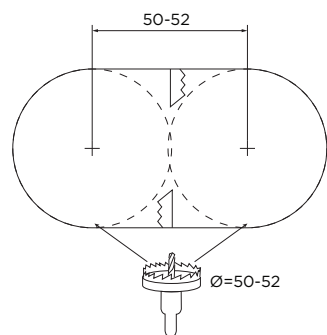

Driver must be powered off before connecting the cables.

Before connecting the luminaire/LED module to the driver please make sure the driver is not powered but disconnected from the mains. The driver can only be powered when the luminaire/LED module is already connected. Disregarding this instruction might damage or even destroy the luminaire/LED module.

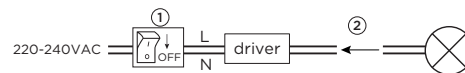

DIMENSIONS

1.0 LED with wire springs

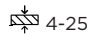
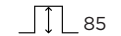

1.0 LED with blade springs

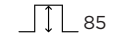

2.0 LED

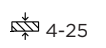
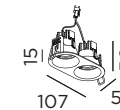

MOUNTING INSTRUCTION

- 1 Make a hole in the ceiling according to the prescribed dimensions.
- 2 **POWER CONNECTION**
Always use a driver according to the specifications of the LED module.

Single Connection

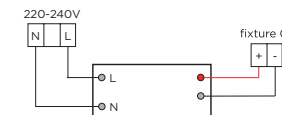

Multiple Connection

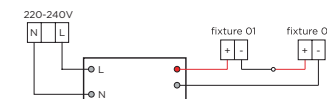

- 3 For wire springs:
Push the springs upwards and insert the fixture in the ceiling hole.
For blade springs:
Push the springs towards the fixture when inserting the fixture in the ceiling hole.

DEEP BIJOU

INSTALLATION INSTRUCTIONS | FEBRUARY 2023

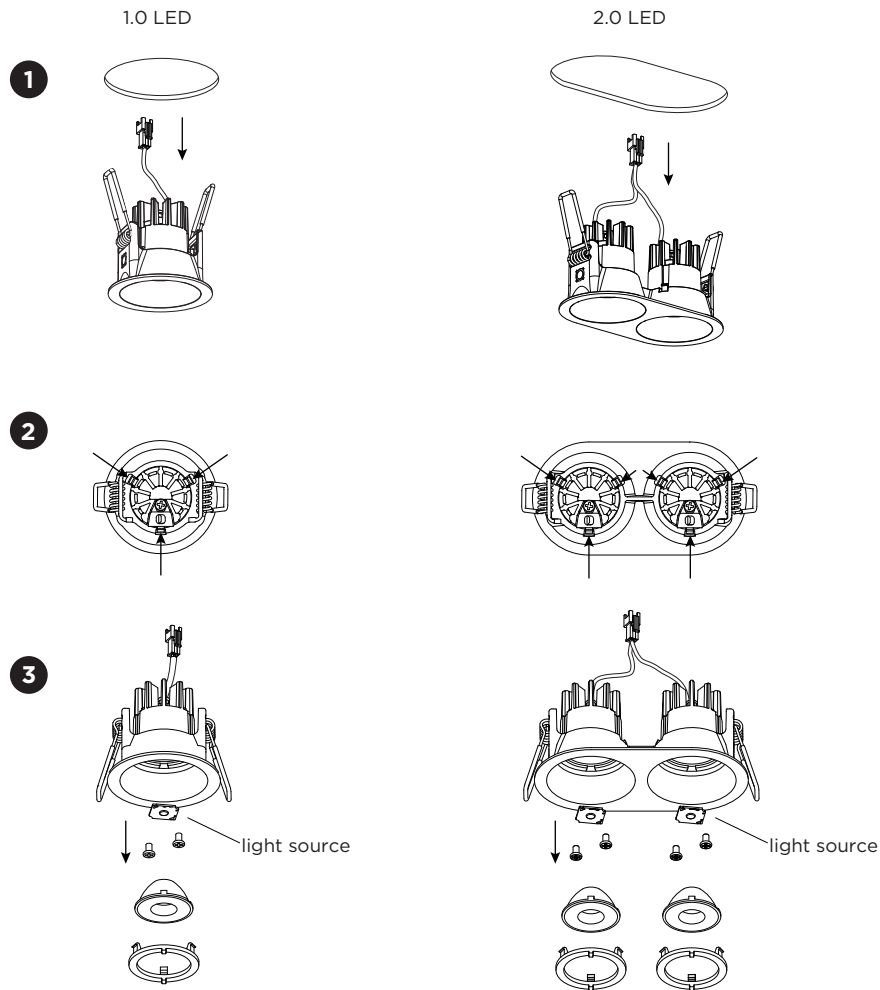

DISMOUNTING AND RECYCLING INSTRUCTIONS

Light source

- 1 Remove the fixture from the ceiling and disconnect the wires.
- 2 Push at the three points to loosen the front ring(s).
- 3 Take the lens(es) out and unscrew the holder(s) or light source(s) to remove the light source(s).



The light source is replaceable by an authorized professional.
For advice contact your Wever & Ducré customer service contact point.



This luminaire contains a light source with the energy class D.